

SU-POR[®]
Surgical Implants

 **Tecnoprótesis**
Soluciones médicas
Distribuidor Oficial de
SU-POR

Craniomaxillofacial Implants
from **PORIFEROUS**

Why SU-POR?

SU-POR Surgical Implants are manufactured from a linear high-density polyethylene. SU-POR Surgical Implants allow for tissue ingrowth because of the interconnecting open pore structure. The firm nature of the material allows carving with a sharp instrument without collapsing the pore structure. SU-POR Surgical Implants, available in blocks, sheets and preformed anatomical shapes are intended for non-weight bearing applications of craniofacial reconstruction/cosmetic surgery and repair of craniofacial trauma. SU-POR Surgical Implants are also intended for augmentation and restoration of contour in the craniomaxillofacial skeleton

The porosity of SU-POR Surgical Implants is maintained large, with average pore sizes greater than 100 microns and pore volume in the 50% range (measured by Mercury Intrusion Porosimetry). Clinical experience and animal studies have shown that tissue will grow into the open pores of porous polyethylene. The clinical significance of tissue ingrowth may vary with the application and implant site. Invitro and invivo biocompatibility studies have shown SU-POR Surgical Implants to be free from any observable systemic or cytotoxic effects.

The success of any implant is dependent upon careful handling and proper surgical technique. Porous materials are particularly susceptible to contamination either by micro-organisms or foreign material. In order to reduce the chance of contamination during preoperative handling, the highest level of aseptic care must be used. SU-POR Surgical Implants should remain in the protective pouch until the implant site has been prepared.

Select from an array of anatomical shapes, sheets, blocks, and spheres including:

- o Preformed shapes for chin, malar, rim, midface and mandibular augmentation
- o Reconstructive shapes for traumatic defects
- o Sheets, wedges and blocks for orbital floor and wall repair
- o Spheres and Conical Orbital Implants for enucleation and evisceration procedures

The intent of this brochure is to provide the surgeon with illustrations and dimensions of the many shapes of SU-POR Surgical Implants. Implants can be customized to accommodate the individual need of the patient.

Surgeons should utilize proper surgical techniques for which they were trained and their clinical experience to determine appropriate surgical procedures. Successful implantations are technique sensitive. Sound surgical judgment should be used in the selection/shaping and implantation of SU-POR Surgical Implants.

Implant Preparation

SU-POR Surgical Implants are sold sterile and should never be re-sterilized. Prior to handling the implant, operating room personnel should put on a clean pair of powder free gloves. Keep the implant in its protective packaging until time of implantation. Upon opening the inner pouch, the implant should be placed in a sterile antibiotic solution of the surgeon's preference. Strict adherence to the principles of aseptic technique should be followed with these implants. Proper surgical procedures and techniques are necessarily the responsibility of the medical professional.

Cutting

SU-POR Surgical Implants are readily cut with surgical instruments. The material may be carved using scalpel, burr, or cut with scissors, care should be taken to smooth the edges of the implant where it transitions to bone. Trim any poorly attached implant material from the edges. After carving and sculpting is complete, wash the implant with sterile saline to remove any loose particles from its surface and edges.

Contouring & Molding

To help the shaping process, the implant can be submerged in a hot, sterile saline bath (82° - 100°C, 180° - 212°F). Having been heated, the implant will be more flexible allowing for modification to the shape. If the implant cools and becomes difficult to bend, it should be returned to the hot saline. Once the desired shape is obtained, the implant should be held in that shape and allowed to cool. A cold, sterile bath can be used to accelerate the cooling process. Repeat the above steps if further molding is required.

Implant Stabilization

Stabilization and fixing of the implant, if desired, can be accomplished by means of proper rigid fixation techniques. For screw fixation, the screw will compress the implant to the bone and will allow the surgeon to sink the screw head even with the surface of the implant. The surface of the implant can easily be penetrated with a cutting needle, enabling the surgeon to suture it to tissues or muscle. Advantages of stabilizing the implant are the ability to contour and finely modify the edges of the implant, in situ, after fixation.

Surgical Revisions

The porous nature of SU-POR Surgical Implants allows for soft tissue ingrowth and vascularization of the implant. In patients that may require later surgical revision, the surgeon should be aware of this vascular and soft tissue ingrowth. In the event revision or removal of the implant is required after ingrowth has occurred, the surrounding soft tissue may be raised with a surgical instrument and the implant dissected out with a scalpel or surgical scissors.

Sheet

The SU-POR (biomaterial) Sheet provides surgeons with an excellent option for craniofacial reconstruction and augmentation

Cat #	A	B	C
4001	38mm	50mm	0.25mm
4002	50mm	76mm	0.25mm
4003	38mm	50mm	0.35mm
4004	50mm	76mm	0.35mm
4005	30mm	50mm	0.40mm
4006	38mm	50mm	0.45mm
4007	50mm	76mm	0.45mm
4008	38mm	50mm	0.85mm
4009	50mm	76mm	0.85mm
4012	38mm	50mm	1.5mm
4013	50mm	76mm	1.5mm
4015	38mm	50mm	3.0mm

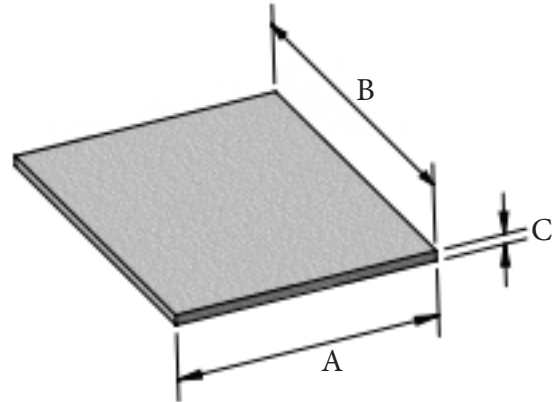

Membrane Sheet

The SU-POR Membrane Sheet is designed to selectively prevent tissue attachment to one side of the implant surface. The membrane layer is comprised of solid polyethylene and heat bonded to the porous layer without adhesives or additives. Tissue integration occurs in the porous layer just as with the fully porous Sheet implant.

Cat #	A	B	C
4231**	38mm	50mm	0.60mm
4016	38mm	50mm	1.0mm
4241	38mm	50mm	1.6mm
4017	50mm	76mm	1.0mm
4018	50mm	76mm	1.6mm

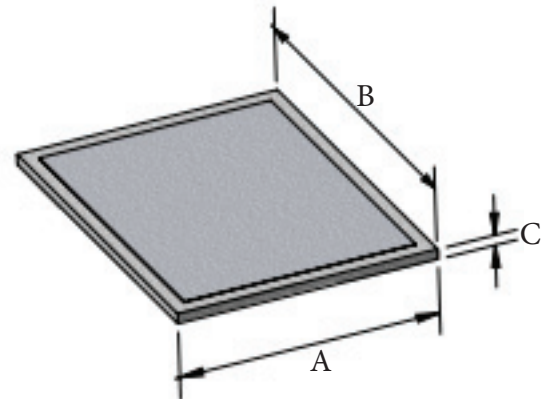

Flor-Tec™ Composite Orbital Floor** Designed with William R. Nunery, M.D., FACS

The Flor-Tec is a composite structure of SU-POR biomaterial comprised of a solid primary section and a leading porous strip. Solid high-density polyethylene acts to prevent tissue ingrowth while the porous strip may help to facilitate implant attachment.

Cat #	A	B	C
4233	38mm	50mm	0.30mm
4232	38mm	50mm	0.40mm
4234	38mm	50mm	0.50mm

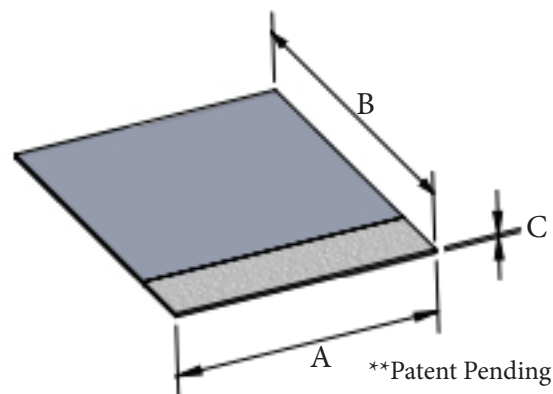

Enophthalmos Wedge

The Enophthalmos Wedge is designed to mimic the shape of the orbital floor and designed to restore the shape of the orbit.

Cat #	Description	A	B	C
4180	Regular - Left	24mm	33.5mm	7mm
4181	Regular - Right	24mm	33.5mm	7mm
4182	Large - Left	28mm	40mm	7.5mm
4183	Large - Right	28mm	40mm	7.5mm

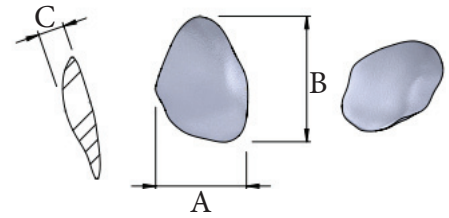

Microplate Single Channel Sheet

The Microplate Single Channel Sheet is designed for repair of significant orbital floor and wall trauma where the addition of a rigid fixation plate provides structural support. The Microplate Single Channel Sheet accepts plates 1.0mm wide and smaller.

Cat #	A	B	C
4297*	38mm	50mm	0.85mm

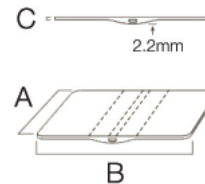

Membrane Microplate Single Channel Sheet

The Membrane Microplate Single Channel Sheet is designed for repair of significant orbital floor and wall trauma where the addition of a rigid fixation plate provides structural support. The Membrane Microplate Single Channel Sheet accepts plates 1.0mm wide and smaller.

Cat #	A	B	C
4296*	38mm	50mm	0.85mm

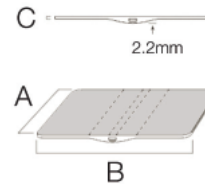

Miniplate Channel Sheet

The Miniplate Channel Sheet is designed for repair of significant orbital floor and wall trauma where the addition of a rigid fixation plate provides structural support.

Cat #	A	B	C
4298*	40mm	52mm	2.3mm

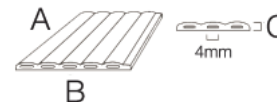

Microplate Channel Sheet

The Microplate Channel Sheet is designed for repair of significant orbital floor and wall trauma where the addition of a rigid fixation plate provides structural support.

Cat #	A	B	C
4299*	40mm	52mm	2.3mm

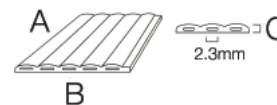

Membrane Miniplate Channel Sheet

The Membrane Miniplate Channel Sheet is designed for repair of significant orbital floor and wall trauma where the addition of a rigid fixation plate provides structural support. The Membrane Layer acts to inhibit tissue ingrowth.

Cat #	A	B	C
4300*	40mm	52mm	2.3mm

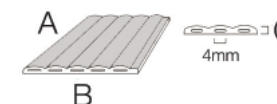

Membrane Microplate Channel Sheet

The Membrane Microplate Channel Sheet is designed for repair of significant orbital floor and wall trauma where the addition of a rigid fixation plate provides structural support. The Membrane Layer acts to inhibit tissue ingrowth.

Cat #	A	B	C
4301*	40mm	52mm	2.3mm

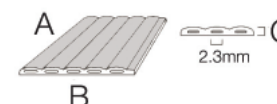

Sphere

The SU-POR Sphere provides surgeons with an excellent fully porous option for enucleation and evisceration procedures. The Sphere is available in multiple sizes to ensure the best possible fit.

Cat #	Diameter
4028	14mm
4029	16mm
4030	18mm
4031	19mm
4032	20mm
4033	21mm
4034	22mm
4035	23mm



Cor-Tec™ Sphere**

The Cor-Tec Sphere is an ocular implant with a thin porous layer surrounding a solid core. Full tissue integration is achieved within the thin outer porous layer.

Cat #	Diameter
4042	16mm
4043	18mm
4045	20mm
4047	22mm

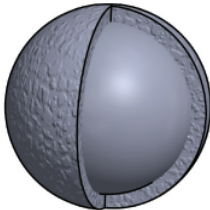

Quadro-Port Tunnel Orbital Sphere Designed with Steven C. Dresner, M.D.

The Quadro-Port Tunnel Orbital Sphere is an ocular implant with a smooth anterior surface and pre-fabricated tunnels for sutures to pass through when attaching extraocular muscles.

Cat #	Diameter
4036	16mm
4037	18mm
4039	20mm
4041	22mm

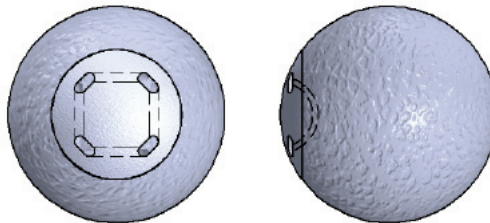

Conical Orbital Implant (COI)

The Conical Orbital Implant (COI) provides an excellent option for enucleation and evisceration procedures where more volume is required. The conical shape provides more volume posteriorly; approximately equivalent to the volume of a sphere with 2mm larger diameter.

Cat #	Dimensions
4054	3.0 ml Volume - 16mm Diameter
4055	4.2 ml Volume - 18mm Diameter
4057	5.6 ml Volume - 20mm Diameter
4058	7.4 ml Volume - 22mm Diameter



Quadro-Port Tunnel Conical Orbital Implant (COI)

Designed with Steven C. Dresner, M.D.

The Quadro-Port Tunnel Conical Orbital Implant (COI) is a conical shaped ocular implant with a smooth anterior surface and pre-fabricated tunnels for sutures to pass through when attaching extraocular muscles. The conical shape provides more volume posteriorly; approximately equivalent to the volume of a sphere with 2mm larger diameter.

Cat #	Dimensions
4059	3.0 ml Volume - 16mm Diameter
4060	4.2 ml Volume - 18mm Diameter
4062	5.6 ml Volume - 20mm Diameter
4063	7.4 ml Volume - 22mm Diameter

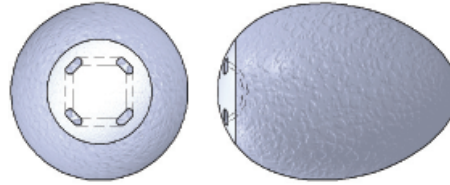

Inferior Orbital Rim

The Inferior Orbital Rim can provide up to 5mm of anterior projection and is designed to be trimmed to meet the needs of the individual patient.

Cat #	Description	A	B	C
4064	Left	43mm	18mm	3.2mm
4065	Right	43mm	18mm	3.2mm

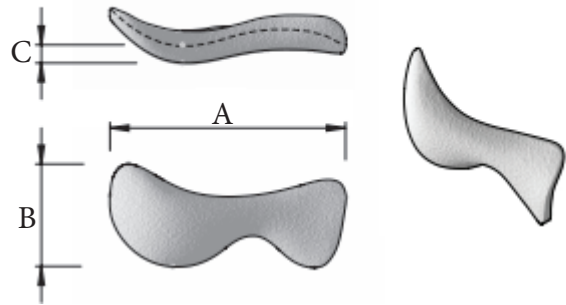

Inferior Medial Orbital Rim

Designed with Rona Z. Silkiss, M.D., FACS

The Inferior Medial Orbital Rim is designed to be placed over the inferior orbital rim and extend superiorly and inferiorly medial to the inferior orbital nerve.

Cat #	Description	A	B	C
4191	Left	25mm	26mm	2.5mm
4192	Right	25mm	26mm	2.5mm

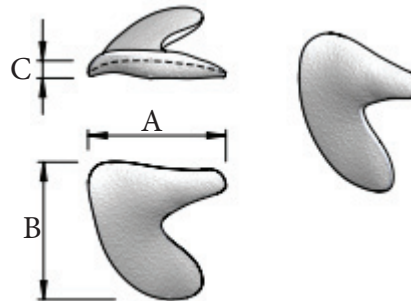

Superior Lateral Orbital Rim Designed with Oscar M. Ramirez, M.D.

The Superior Lateral Orbital Rim is designed to augment the lateral and superior orbital rims, and is designed to be trimmed to meet the needs of the individual patient.

Cat #	Description	A	B
4251	Left	33mm	45mm
4252	Right	33mm	45mm

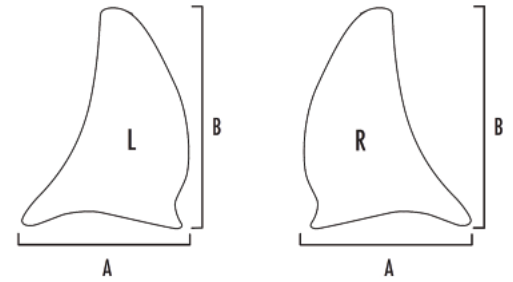

Extended Orbital Rim Designed with Robert A. Goldberg, M.D.

The Extended Orbital Rim provides surgeons with a large amount of implant to work with, allowing for trimming as required, to fit a large array of orbital rim defects.

Cat #	Description	A	B	C
4066	Left	47mm	40mm	6.33mm
4067	Right	47mm	40mm	6.33mm

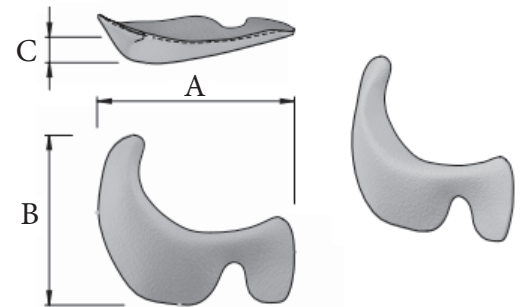

Orbital Rim Onlay Designed with Robert A. Goldberg, M.D.

The Orbital Rim Onlay is designed to augment the lateral and inferior orbital rims and subtly increase the anterior projection.

Cat #	Description	A	B	C
4253	Left	40mm	40mm	8.45mm
4254	Right	40mm	40mm	8.45mm

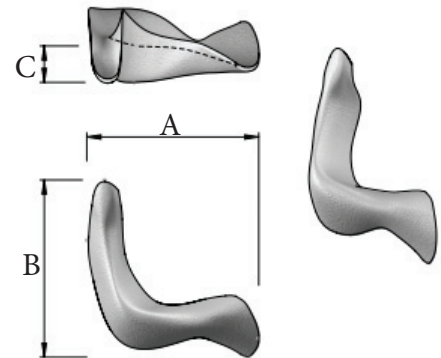

Midface Contour

The Midface Contour is an onlay designed to augment or repair the non-load bearing bony structures of the midface.

Cat #	Description	A	B	C
4255	Left	60mm	40mm	4mm
4256	Right	60mm	40mm	4mm

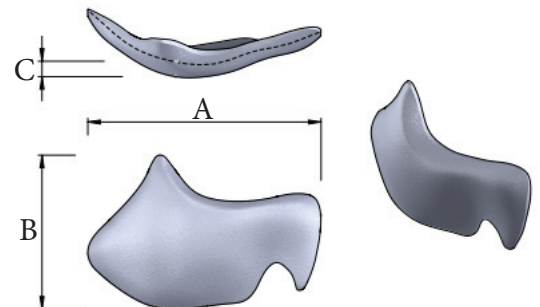

Midface Rim

The Midface Rim is designed to augment and repair non-load bearing bony structures of the midface and the inferior orbital rim.

Cat #	Description	A	B	C
4189	Left	47mm	28mm	3mm
4190	Right	47mm	28mm	3mm

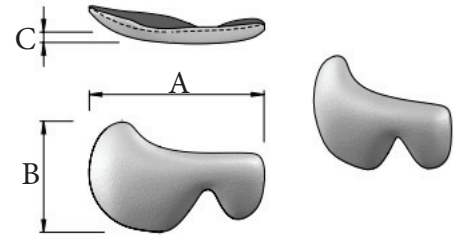

Inferior 2/3 Orbit

The Inferior 2/3 Orbit is designed to replace non-load bearing bony structures of the inferior orbit.

Cat #	Description	A	B	C
4224*	Left	61mm	97mm	60mm
4225*	Right	61mm	97mm	60mm

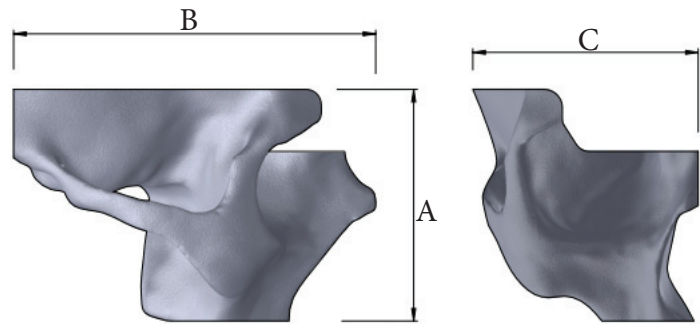

Complete Orbit

The Complete Orbit is designed to replace non-load bearing bony structures of the orbit.

Cat #	Description	A	B	C
4226*	Left	77mm	97mm	63mm
4227*	Right	77mm	97mm	63mm

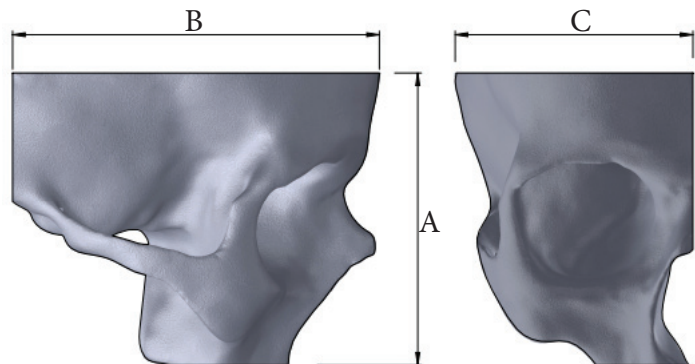

Extended Malar

The Extended Malar is designed to add more volume to the malar or to rebuild the contour of the bony structure.

Cat #	Description	A	B	C
4201	Small - Left	45mm	24mm	3mm
4202	Small - Right	45mm	24mm	3mm
4203	Medium - Left	50mm	26mm	4mm
4204	Medium - Right	50mm	26mm	4mm
4205	Large - Left	55mm	27mm	5mm
4206	Large - Right	55mm	27mm	5mm

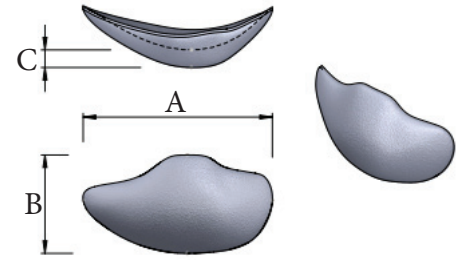

SP1 Malar Designed with Oscar M. Ramirez, M.D.

The SP1 Malar is designed to subtly augment the malar bone.

Cat #	Description	A	B	C
4082	Small - Left	50mm	19mm	3mm
4083	Small - Right	50mm	19mm	3mm
4084	Regular - Left	50mm	19mm	5mm
4085	Regular - Right	50mm	19mm	5mm

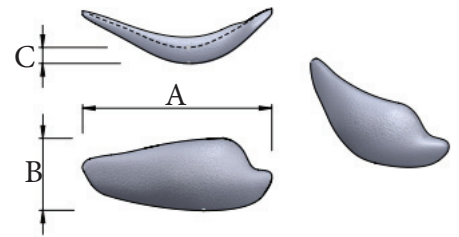

SP2 Malar

The SP2 Malar is designed to subtly augment the malar bone.

Cat #	Description	A	B	C
4086	Small - Left	64mm	19mm	3mm
4087	Small - Right	64mm	19mm	3mm
4197	Medium - Left	64mm	19mm	4.5mm
4198	Medium - Right	64mm	19mm	4.5mm
4199	Large - Left	64mm	19mm	7mm
4200	Large - Right	64mm	19mm	7mm

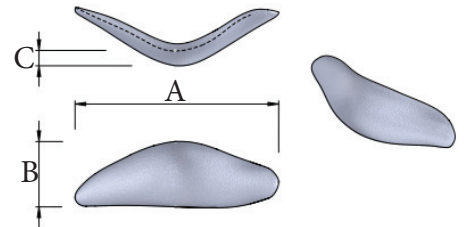

Contoured Two-Piece Chin

The Contoured Two-Piece Chin is designed with a gradual taper and concave posterior surface to provide an excellent anatomical fit to the bony anatomy.

Cat #	Description	A	B	C
4088	Small	72mm	42mm	3mm
4089	Medium	74mm	42mm	5mm
4090	Large	78mm	50mm	7mm
4091	Extra Large	80mm	55mm	9mm

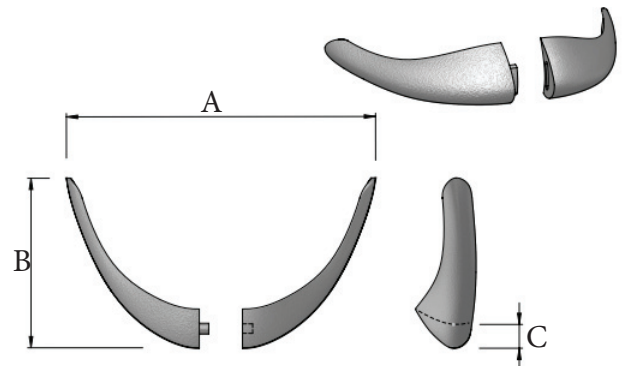

Two-Piece Chin

The Two-Piece Chin is designed to allow for easy insertion and placement of the implant. The surgeon can then attach the components together for proper alignment.

Cat #	Description	A	B	C
4092	Small	56mm	33mm	5mm
4093	Medium	56mm	36mm	7mm
4094	Large	57mm	38mm	9mm

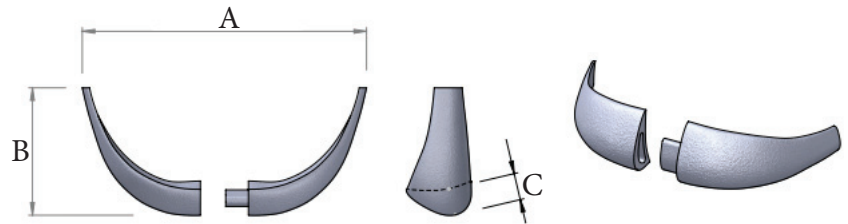

Button Chin

The Button Chin is designed for subtle augmentation to the medial anterior point of the chin. Having multiple sizes allows the surgeon to select the most natural looking configuration.

Cat #	Description	A	B	C
4265*	Small	40mm	25mm	4mm
4266	Medium	47.5mm	37.5mm	5.5mm
4267	Large	48.5mm	38mm	7mm

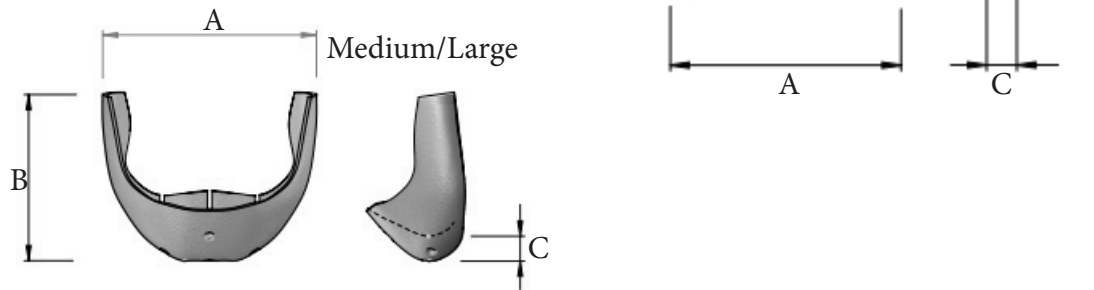

Round Extended Chin

The Round Extended Chin is designed to provide tri-dimensional projection (anterior, lateral and inferior).

Cat #	Description	A	B	C
4259*	Small	45mm	47mm	3mm
4260*	Medium	45mm	47mm	5mm
4261*	Large	45mm	47mm	7mm

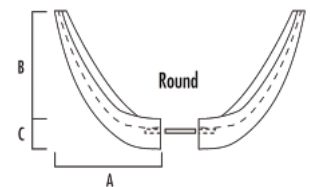

Square Extended Chin

The Square Extended Chin is designed to provide tri-dimensional projection (anterior, lateral, and inferior).

Cat #	Description	A	B	C
4262*	Small	45mm	47mm	3mm
4263*	Medium	45mm	47mm	5mm
4264*	Large	45mm	47mm	7mm

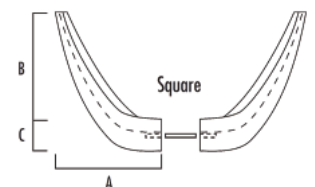

Geniomandibular Groove

The Geniomandibular Groove is designed to augment the geniomandibular groove. The implant is divided medially for separate insertion of the left and right pieces.

Cat #	A	B	C
4302*	45mm	41mm	4mm

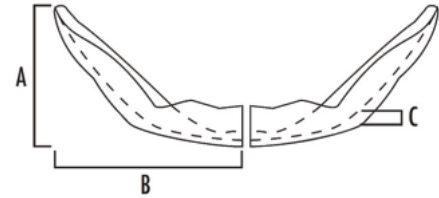

Contoured Mandibular Angle

The Contoured Mandibular Angle is designed to subtly augment the mandible.

Cat #	Description	A	B	C
4303	Left	59mm	29mm	7mm
4304	Right	59mm	29mm	7mm

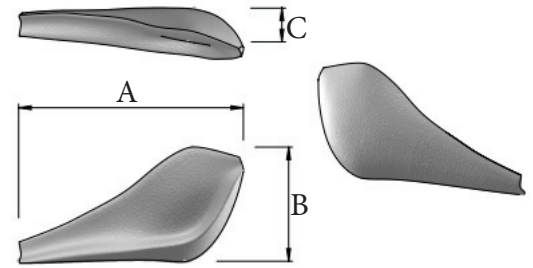

SP Mandibular Angle Designed with Oscar M. Ramirez, M.D.

The SP Mandibular Angle is designed to conform to the posterior and inferior borders of the mandibular angle.

Cat #	Description	A	B	C
4150	Small - Left	65mm	35mm	3mm
4151	Small - Right	65mm	35mm	3mm
4152	Medium - Left	65mm	35mm	7mm
4153	Medium - Right	65mm	35mm	7mm
4154	Large - Left	65mm	35mm	11mm
4155	Large - Right	65mm	35mm	11mm

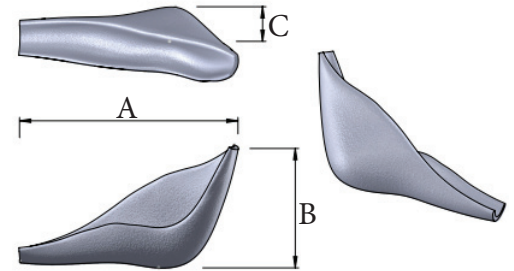

Lateral Augmentation Mandible

The Lateral Augmentation Mandible is designed to subtly augment the lateral projection of the mandible.

Cat #	Description	A	B	C	D	E
4305	Regular - Left	47mm	38mm	3mm	3mm	6.5mm
4306	Regular - Right	47mm	38mm	3mm	3mm	6.5mm
4307	Large - Left	57mm	40mm	4mm	3mm	10mm
4308	Large - Right	57mm	40mm	4mm	3mm	10mm

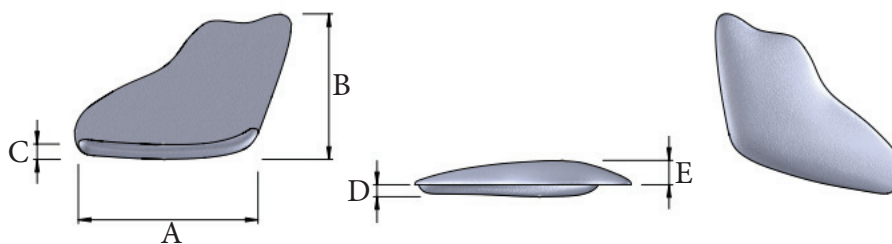

Ramus of the Mandible

The Ramus of the Mandible is designed for augmentation of the ramus of the mandible.

Cat #	Description	A	B	C	D	E
4095*	Large 5mm - Left	79mm	32mm	5mm	10mm	7mm
4096*	Large 5mm - Right	79mm	32mm	5mm	10mm	7mm
4097*	Large 10mm - Left	79mm	32mm	10mm	10mm	7mm
4098*	Large 10mm - Right	79mm	32mm	10mm	10mm	7mm
4145*	Regular 5mm - Left	79mm	32mm	5mm	4mm	5mm
4146*	Regular 5mm - Right	79mm	32mm	5mm	4mm	5mm
4147*	Regular 10mm - Left	79mm	32mm <td 10mm	4mm	5mm	
4148*	Regular 10mm - Right	79mm	32mm	10mm	4mm	5mm

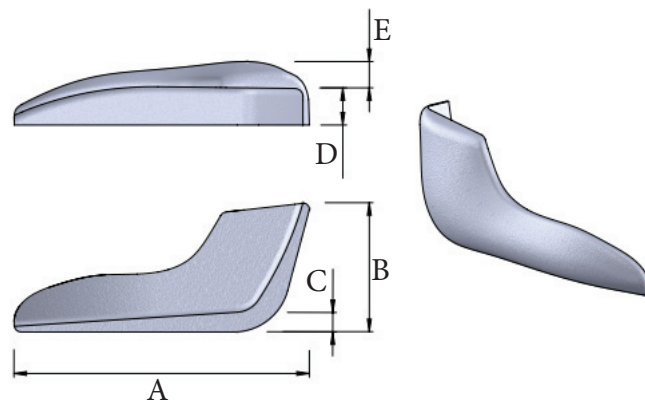

Two-Piece Auricular Implant

The design of the SU-POR Auricular implants allow for surgeons to custom shape the height and projection of the helical rim to match the contralateral ear of the patient. The porous material provides a structural base for a temporal parietal fascia flap and skin grafts. The success of the implant depends on the technique of the surgeon; the porous structure requires a vascular tissue flap such as a temporal parietal fascia flap and skin graft, to prevent late exposure of the implant.

Cat #	Description	A	B
4099	Ear Base - Left	32mm	63mm
4100	Ear Base - Right	32mm	63mm
4101	Helical Rim - Left	39mm	63mm
4102	Helical Rim - Right	39mm	63mm

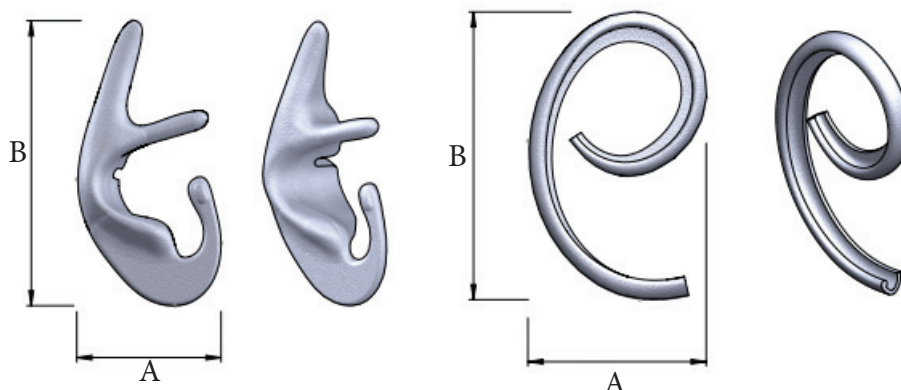

Ear Wedge

The Ear Wedge is designed to enhance the projection of a surgically reconstructed ear. The Ear Wedge can be trimmed to match the projection of the contralateral ear.

Cat #	Description	A	B	C
4292	Right	15mm	44mm	11mm
4293	Left	15mm	44mm	11mm

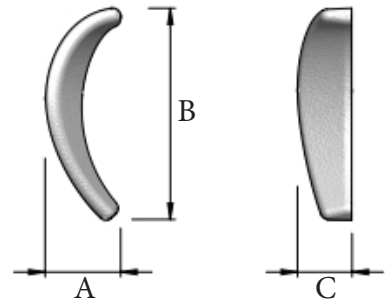

Nasal Dorsal Shell

The Nasal Dorsal Shell provides surgeons with an excellent option for augmenting or correcting deformities of the nose.

Cat #	A	B	C
4103	43mm	16mm	22mm

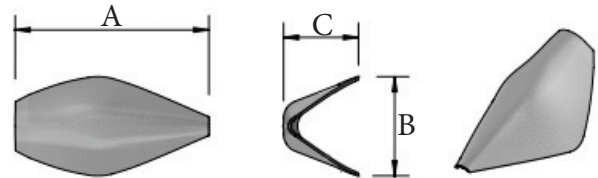

Nasal Batten (2 Per Package)

The Nasal Batten is designed for nasal reconstruction procedures involving the external nasal valve. Nasal Battens are packaged 2 per package.

Cat #	A	B	C
4240	25mm	12.5mm	0.60mm

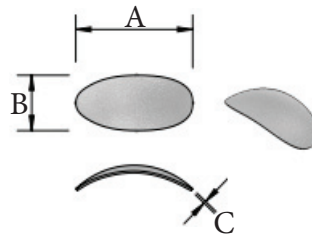

Nasal Sheet

The Nasal Sheet provides surgeons with a solution for when nasal tip projection is required. The Nasal Sheet can be used to support the tip by implantation between the medial crura of the alar cartilage.

Cat #	A	B	C
4107	40mm	9mm	1.1mm

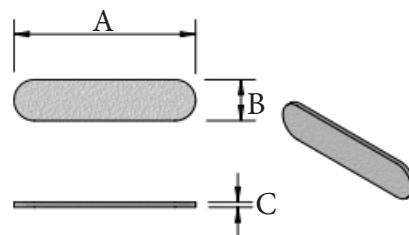

Nasal Radix

The Nasal Radix offers surgeons an excellent option to augment a low nasal radix.

Cat #	A	B	C
4243	24mm	3mm	10mm

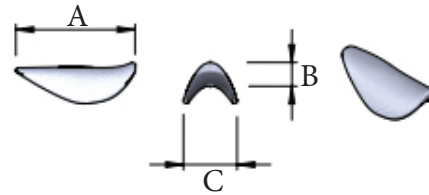

Nasal Arch

The Nasal Arch can be used effectively to create a nasal onlay where subtle augmentation of the dorsum is required. Care should be taken to place the Nasal Arch appropriately in the dorsum area and to avoid extending the Nasal Arch proximally into the soft nasal cartilage area of the tip. The edge of the Nasal Arch should be feathered to promote a smooth transition from the implant to the patient's natural contour.

Cat #	Description	A	B	C
4244	Small	70mm	13mm	2mm
4245	Medium	70mm	15mm	2mm
4246	Large	70mm	17mm	2mm

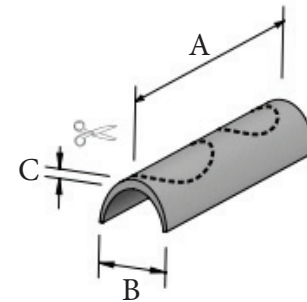

Nasal Dorsum

The Nasal Dorsum is designed to provide subtle augmentation to the dorsum.

Cat #	Description	A	B	C
4104	Tapered	55mm	6mm	9mm
4239	Small	54mm	6mm	11mm
4238	Large	67mm	9mm	14mm

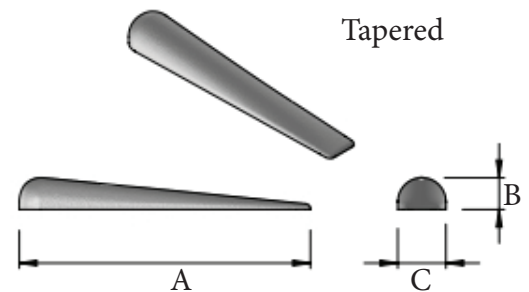
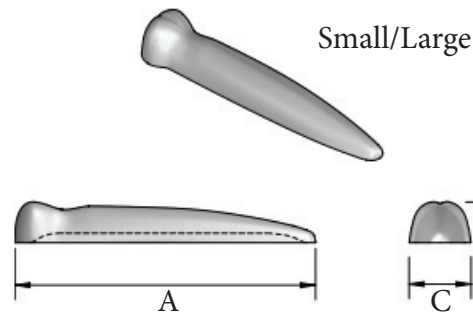

Paranasal

Paranasal implants are designed for augmentation and restoration of the midface in patients who have midfacial deficiency.

Cat #	Description	A	B	C
4156	Small - Left	28mm	26mm	4.5mm
4157	Small - Right	28mm	26mm	4.5mm
4158	Large - Left	30mm	28mm	7mm
4159	Large - Right	30mm	28mm	7mm

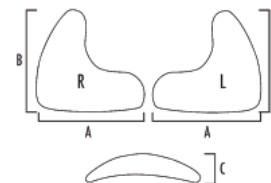

Pterional

The Pterional is designed to correct temporal hollowing in patients who have had surgery involving the pterional approach to the brain. The implant is placed deep to the temporalis during closure.

Cat #	Description	A	B	C
4122	Left	6mm	43mm	44mm
4123	Right	6mm	43mm	44mm

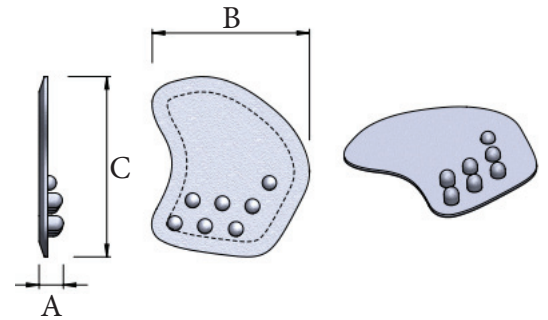

Mastoid

The Mastoid provides surgeons with an excellent option for repair of mastoid defects. The regular Mastoid is available in left and right configurations while the small Mastoid provides a universal fit.

Cat #	Description	A	B	C
4132	Small	36mm	45mm	1.5mm
4124	Left	56mm	53.3mm	1.5mm
4125	Right	56mm	53.3mm	1.5mm

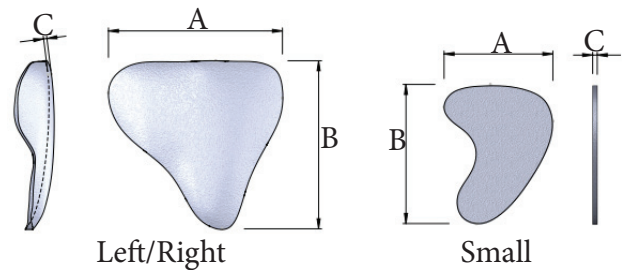

Cranial Flex Grid

The Cranial Flex Grid is designed to fill full thickness cranial defects as an option to calvarial bone grafts. The Cranial Flex Grid has a design that is strong and flexible and allows for the implant to be cut to the desired shape.

Cat #	A	B	C
4108	97mm	106mm	6mm

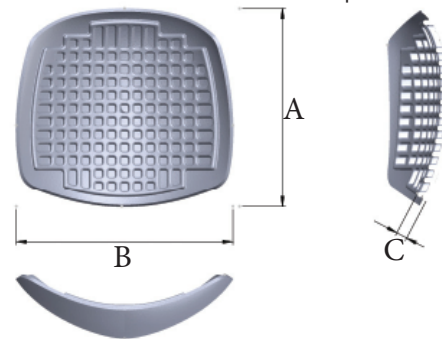

Temporal Flex Grid

The Temporal Flex Grid is designed to augment deficient soft tissue in the temporal region. The Temporal Flex Grid has a thin contoured temporal surface designed for a proper anatomical fit and a more natural result.

Cat #	Description	A	B	C
4110	Small - Left	61mm	78mm	18mm
4111	Small - Right	61mm	78mm	18mm
4112	Medium - Left	74mm	93mm	20mm
4113	Medium - Right	74mm	93mm	20mm
4114	Large - Left	82mm	105mm	20mm
4115	Large - Right	82mm	105mm	20mm
4363	SP - Small	70mm	70mm	10mm
4364	SP - Medium	88mm	86mm	15mm
4365	SP - Large	98mm	95mm	18mm

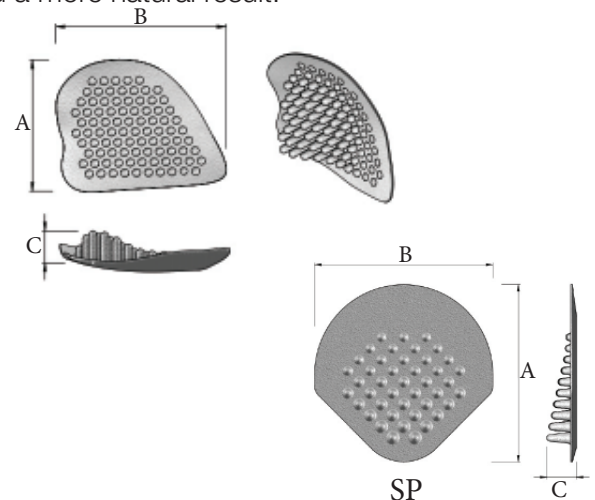

Sellar Floor

The Sellar Floor is designed to repair the sellar floor. It is available in two sizes and configurations. The larger Sellar Floor is designed with three small tabs to facilitate handling and placement while the regular has a single tab. The Large Sellar Floor also has a membrane layer to aid in preventing tissue ingrowth.

Cat #	Description	A	B	C	D
4126	Regular	20mm	20mm	2.5mm	0.45mm
4129	Large + Membrane	40mm	40mm	2.5mm	0.73mm

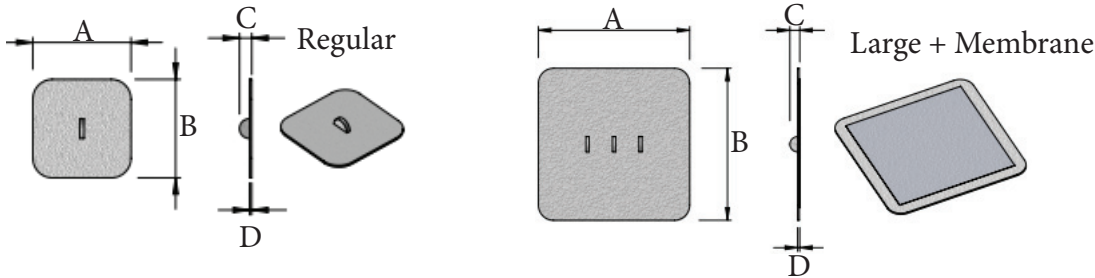

Cranial Hemisphere

The Cranial Hemisphere is designed to provide surgeons with a reconstructive option for large cranial defects. The Cranial Hemisphere provides alternatives to customized implants, grafts, and other implant materials.

Cat #	Description	A	B	C
4116	Left	124mm	170mm	4.5mm
4117	Right	124mm	170mm	4.5mm
4118	Left	124mm	170mm	6mm
4119	Right	124mm	170mm	6mm

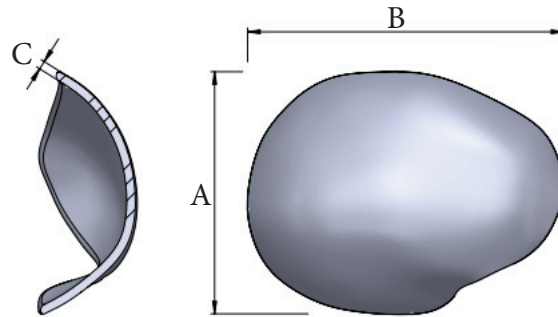

Cranial Dome

The Cranial Dome is designed to provide surgeons with a reconstructive option for large cranial defects. The Cranial Dome approximates the contour of the superior 1/3 of the cranium and is available in two thicknesses.

Cat #	A	B	C
4120	150mm	180mm	4mm
4121	150mm	180mm	6mm

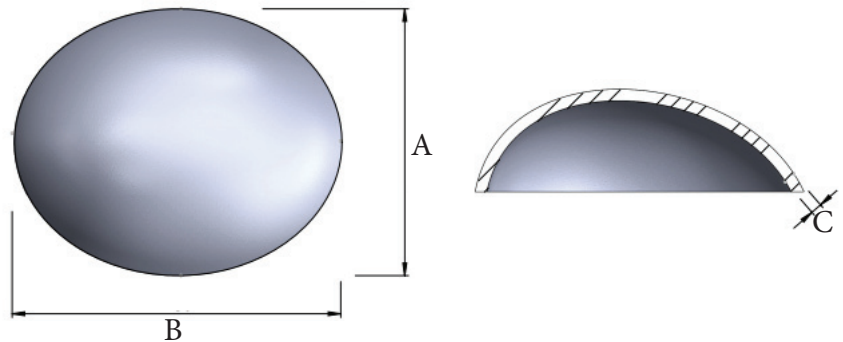

Orbito-Zygomatic

The Orbito-Zygomatic is designed for reconstruction of the superior and lateral surfaces of the orbital roof.

Cat #	Description	A	B	C
4072	Left	33mm	38mm	0.8mm
4073	Right	33mm	38mm	0.8mm

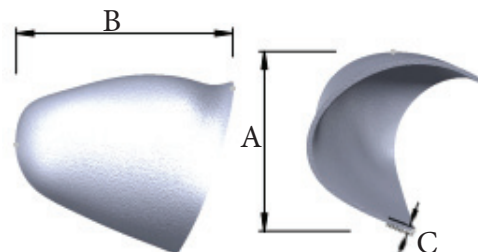

Flex Sheet

The Flex Sheet is designed for small to medium sized cranial defects and deformities. It has a smooth exterior surface and a series of pedicles on the interior surface that are designed to provide volume and flexibility.

Cat #	Description	A	B	C
4109	Regular	56mm	91mm	4.5mm
4134	Regular + Membrane	56mm	91mm	4.5mm

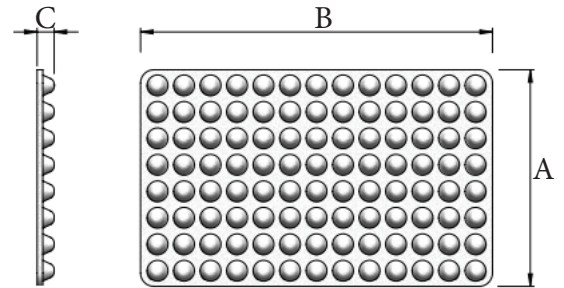

Burr Hole Cover (3 Per Package)

The Burr Hole Cover is designed to fit into and over holes made by a cranial perforator. The large Burr Hole Cover has a 14mm diameter with a stem that is easily modified. The small Burr Hole Cover is designed for 5mm diameter holes.

Cat #	Description	A	B	C
4130	Small	15mm	3mm	5mm
4131	Large	29mm	7mm	14mm

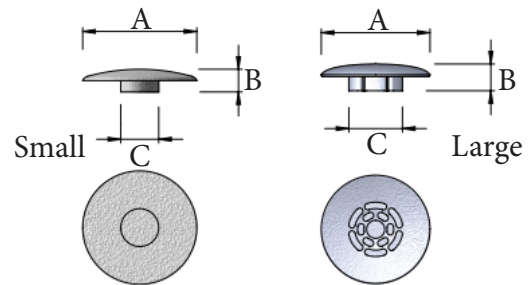

Block

The SU-POR Block gives surgeons excellent options for craniofacial reconstruction and augmentation. SU-POR Block implants are available in multiple sizes and thicknesses to ensure that the surgeon has the proper amount of biomaterial for almost any possible contour or shape required.

Cat #	A	B	C
4019	13mm	38mm	3mm
4020	25mm	50mm	3mm
4021	38mm	63mm	3mm
4022	13mm	38mm	6mm
4023	25mm	50mm	6mm
4024	38mm	63mm	6mm
4025	13mm	38mm	9.5mm
4026	25mm	50mm	9.5mm
4027	38mm	63mm	9.5mm

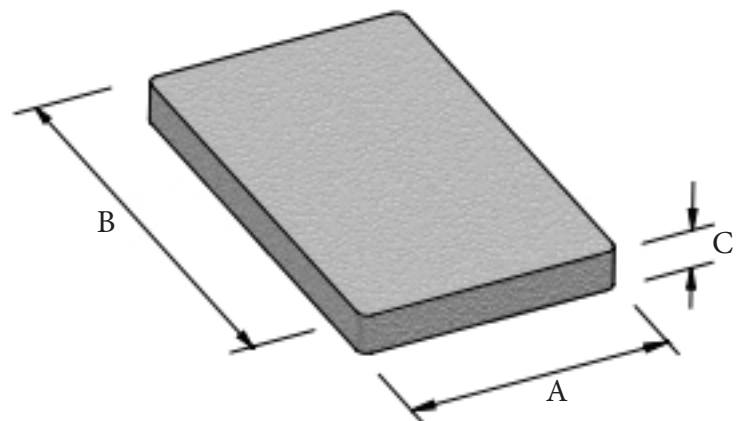

SU-POR[®] Patient-Specific Implants from **PORIFEROUS**

SU-POR Patient-Specific Implants provide surgeons with an excellent alternative to grafts and other implant materials. The ability to transmit the patient's specific DICOM data electronically or by mail on CD/DVD produces a high-quality customized implant that can reduce operating time. SU-POR Patient-Specific Implants are for repair of bilateral defects, or defects involving the orbit and/or facial skeleton. SU-POR Patient-Specific Implants are created using a physical model and a proven design template.

Cat # : Description

4350 : Patient-Specific Cranial Implant (includes periorbital implants). Package includes : online review of skull model, online approval of implant template, one sterile Patient-Specific Implant plus one sterile backup implant (US Only)

4351 : Canial Implant Template add-on (non-implantable)

4353 : Patient-Specific Facial Implant (includes chin, mandible, malar, and midface). Package includes: one sterile Patient-Specific Implant, plus one sterile backup implant (US Only)

4354 : Contralateral charge for Patient-Specific Facial Implant

4355 : Skeletal model of defect area

4356 : Facial Implant Template add-on (non-implantable)

4357 : Bilateral Implant add-on (non-implantable)

Contact Us for a Quote

P: 877.631.1954

info@poriferous.com

www.su-por-ior.com

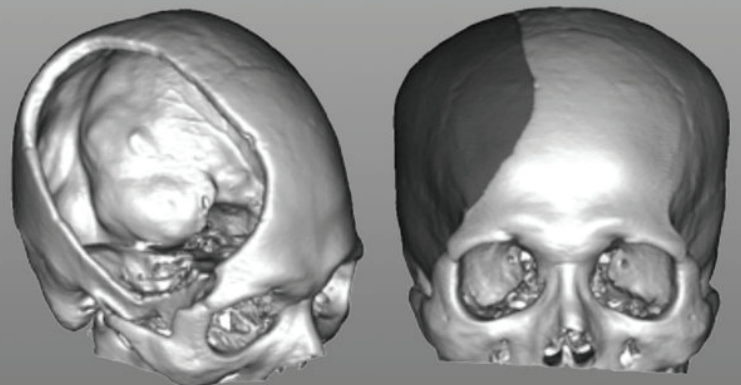

All products shipped by Poriferous, LLC are provided Sterile. DO NOT USE any implant if the package is open, damaged or wet. All STERILE items are considered single use and cannot be re-sterilized. Surgeons should consult the package insert for instructions on the proper use and precautions for any SU-POR[®] Surgical Implants prior to use. For addition information please contact your local SU-POR Surgical Implants distributor. All products manufactured and distributed by Poriferous, LLC are latex free.



Distribuidor Oficial de

SU-POR[®]

TECNO PRÓTESIS SRL

CUIT N° 30-71546609-7

Ing. Brutos N° 91436

Habilitado por el Ministerio de Salud

Subsecretaría de Asistencia en Salud Pública

DISPOSICIÓN SASP N° 994

Contactános:

Esquiú 56 - San Fernando del Valle de Catamarca - Catamarca

tprotesis@gmail.com

383 4786895 / 6.